

ESTATE Table

Zenith



Features:

Estate is a comprehensive family of tables that provide permanent 'localities' for divergent tasks. Serving as either an individual work-point table or a collaboration setting, Estate creates a 'home base' for specific modes of work. Distinguished by the grounded pedestals which come in a selection of profiles, Estate can be configured in ways that best align with varying work tasks and design aspirations.

Options:

- Round & Capsule Fixed Height Pedestal Table
 - Single, Twin or Triple
- Capsule Fixed Height Modesty Pedestal Table
 - Single or Twin
- Capsule Plus Fixed Height Pedestal Table
 - Single
- Capsule Plus Electric Adjust Pedestal Table
 - Single, Single Sided or Pod 2
- Collaborative & Work-point settings:
 - Collaborative setting: The table is intended for meetings/collaborative projects where the number of users fluctuates depending on the task
 - Work-point setting: The table is intended for individual work where users have their own defined space and the quantity of work-points is pre-defined
- Fixed, Above floor or Access floor Bases
- Foot Rail (1050 Fixed Height only), Sky Rail or Ctrl Screen Rail (Capsule Plus Electric Adjust Single Sides & Pod 2 only)
- Ctrl Screens (Sky Rail & Ctrl Screen Rail only)
- Cable Management: Fully Concealed Cabling, Central Click-in Access Lids & Powder/Data frame Mounting Plates
- Floorsense puck

Design: ZENITH DESIGN STUDIO

Warranty: 10 years

Certification: GECA, Greenguard, AFRDI (Capsule Table with Floating Base only)

Load Rating: Maximum dynamic load limit for all electric desks is 100kg including the worktop weight.

Finishes:

Worktop & Click-in Lids: 25mm laminate.
Pedestal Shrouds, Table Support Frame, Cable Management, Foot Rail, & Sky Rail: Powder coated in Zenith House Satin/
Matt/Fine Texture range
Custom colours on request
Stocked models and colours may vary

Zenith House Powder Coat:



Note:
Fine Texture is not suitable on Estate Capsule Plus

Round & Capsule Fixed Height Pedestal - Single

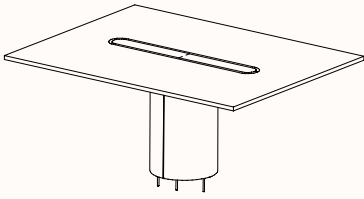

Round Single Pedestal with Fixed Base
(Bolt to Slab)

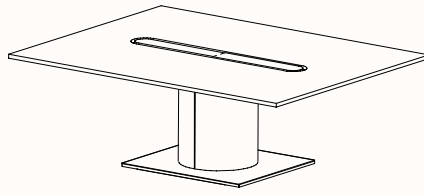

Round Single Pedestal with Above Floor Base
(Floating Base)

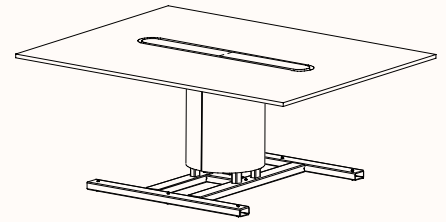

Round Single Pedestal with Access Floor Base
(Floating Base)

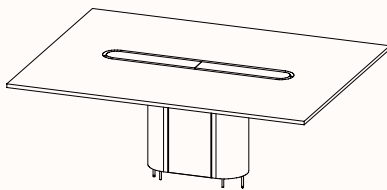

Capsule Single Pedestal with Fixed Base
(Bolt to Slab)

Table length range: 1200 - 3200mm
Table depth range: 1200 - 1800mm

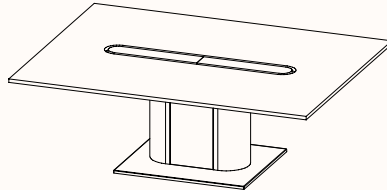

Capsule Single Pedestal with Above Floor Base
(Floating Base)

Table length range: 1200 - 1800mm
Table depth range: 1200 - 1600mm

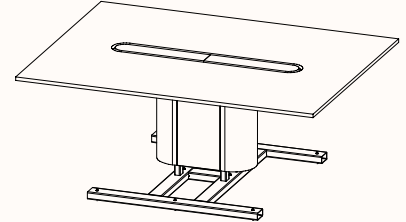

Capsule Single Pedestal with Access Floor Base
(Floating Base)

Table length range: 1200 - 1800mm
Table depth range: 1200 - 1600mm

Suitable for use as a Collaborative* or Work-point** setting

Note * Collaborative settings: The worktop pieces and joins will be calculated to provide the best board efficiency

****** Work-point settings: The number of work-points must be specified.

The individual work-point length limitations are minimum 1200mm to maximum 2400mm.

Each work-point on the table will be equal in length.

Height Range

Fixed Height: 720mm, 900mm & 1050mm

Options

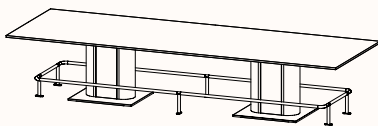

Foot Rail

Available on 1050mmH tables only

Collaborative Setting: The vertical support post quantity & spacing will be calculated to ensure strength & stability.

Work-Point Setting: Vertical support posts will be spaced according to the number of seating positions.

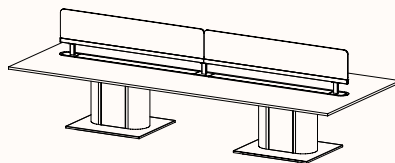

Sky Rail

Consists of an elevated Ctrl Screen Rail

Compatible with Ctrl Screens

The quantity of posts is calculated to ensure strength & stability.

Sky Rail: Comes with click-in lids between the vertical posts

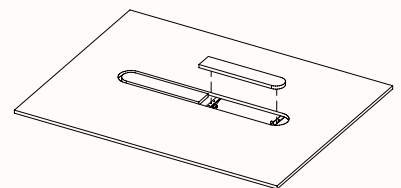

Click-in Lids

Provide quick and easy access to Power/data outlets under the worktop
Capsule shaped

The quantity of lids is calculated to ensure ease of use.

Round & Capsule Fixed Height Pedestal - Twin

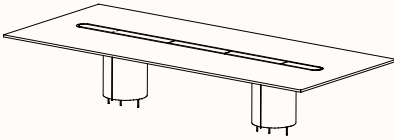

Round Twin Pedestal with Fixed Base
(Bolt to Slab)

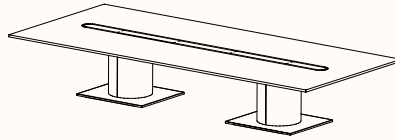

Round Twin Pedestal with Above Floor Base
(Floating Base)

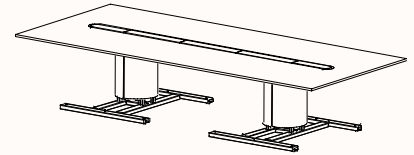

Round Twin Pedestal with Access Floor Base
(Floating Base)

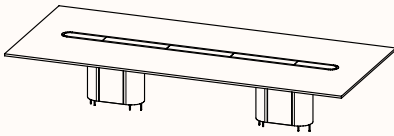

Capsule Twin Pedestal with Fixed Base
(Bolt to Slab)

Table length range: 3200 - 6800mm
Table depth range: 1200 - 1800mm

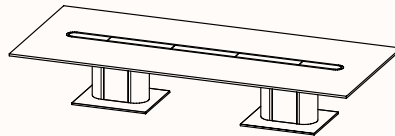

Capsule Twin Pedestal with Above Floor Base
(Floating Base)

Table length range: 2800 - 6000mm
Table depth range: 1200 - 1600mm

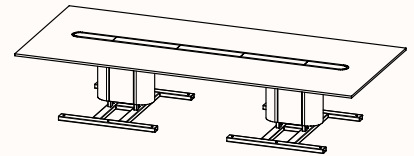

Capsule Twin Pedestal with Access Floor Base
(Floating Base)

Table length range: 2800 - 6000mm
Table depth range: 1200 - 1600mm

Suitable for use as a Collaborative* or Work-point** setting

Note * Collaborative settings: The worktop pieces and joins will be calculated to provide the best board efficiency

****** Work-point settings: The number of work-points must be specified.

The individual work-point length limitations are minimum 1200mm to maximum 2400mm.

Each work-point on the table will be equal in length.

Height Range

Fixed Height: 720mm, 900mm & 1050mm

Options

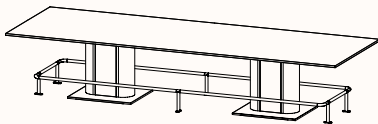

Foot Rail

Available on 1050mmH tables only

Collaborative Setting: The vertical support post quantity & spacing will be calculated to ensure strength & stability.

Work-Point Setting: Vertical support posts will be spaced according to the number of seating positions.

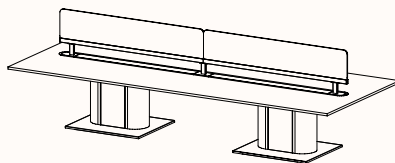

Sky Rail

Consists of an elevated Ctrl Screen Rail

Compatible with Ctrl Screens

The quantity of posts is calculated to ensure strength & stability.

Sky Rail: Comes with click-in lids between the vertical posts

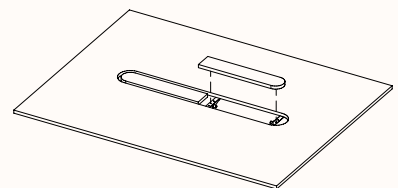

Click-in Lids

Provide quick and easy access to Power/data outlets under the worktop
Capsule shaped

The quantity of lids is calculated to ensure ease of use.

Round & Capsule Fixed Height Pedestal - Triple

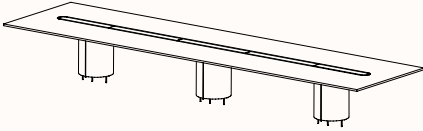

Round Triple Pedestal with Fixed Base
(Bolt to Slab)

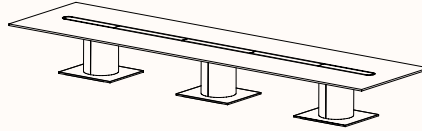

Round Triple Pedestal with Above Floor Base
(Floating Base)

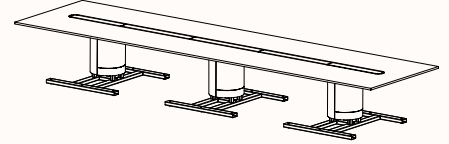

Round Triple Pedestal with Access Floor Base
(Floating Base)

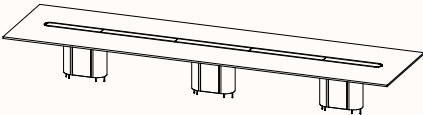

Capsule Triple Pedestal with Fixed Base
(Bolt to Slab)
Table length range: 6800 – 10000mm
Table depth range: 1200 – 1800mm

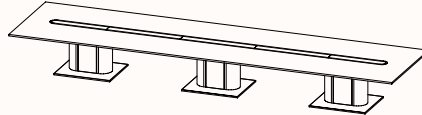

Capsule Triple Pedestal with Above Floor Base
(Floating Base)
Table length range: 5600 – 8400mm
Table depth range: 1200 – 1600mm

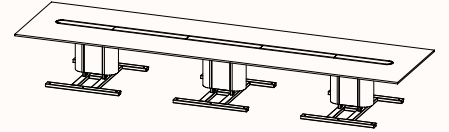

Capsule Triple Pedestal with Access Floor Base
(Floating Base)
Table length range: 5600 – 8400mm
Table depth range: 1200 – 1600mm

Suitable for use as a Collaborative* or Work-point** setting

Note * Collaborative settings: The worktop pieces and joins will be calculated to provide the best board efficiency

****** Work-point settings: The number of work-points must be specified.

The individual work-point length limitations are minimum 1200mm to maximum 2400mm.

Each work-point on the table will be equal in length.

Height Range

Fixed Height: 720mm, 900mm & 1050mm

Options

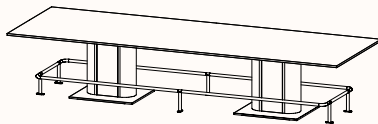

Foot Rail

Available on 1050mmH tables only

Collaborative Setting: The vertical support post quantity & spacing will be calculated to ensure strength & stability.

Work-Point Setting: Vertical support posts will be spaced according to the number of seating positions.

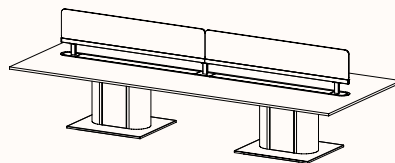

Sky Rail

Consists of an elevated Ctrl Screen Rail

Compatible with Ctrl Screens

The quantity of posts is calculated to ensure strength & stability.

Sky Rail: Comes with click-in lids between the vertical posts

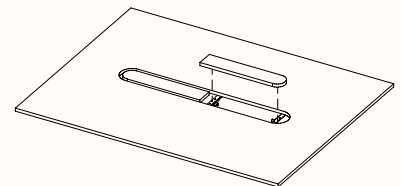

Click-in Lids

Provide quick and easy access to Power/data outlets under the worktop
Capsule shaped

The quantity of lids is calculated to ensure ease of use.

Capsule Modesty Fixed Height Pedestal – Single

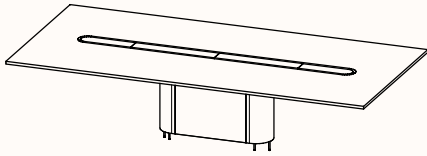

Capsule Modesty Single Pedestal with Fixed Base

(Bolt to Slab)

Table length range: 1800 – 3600mm

Table depth range: 1200 – 1800mm

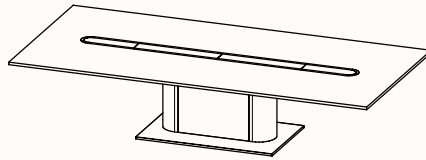

Capsule Modesty Single Pedestal with Above Floor Base

(Floating Base)

Table length range: 1800 – 3200mm

Table depth range: 1200 – 1600mm

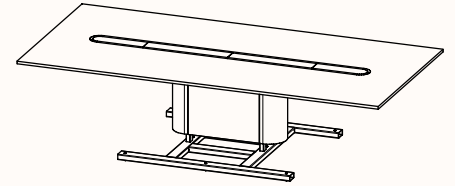

Capsule Modesty Single Pedestal with Access Floor Base

(Floating Base)

Table length range: 1800 – 3200mm

Table depth range: 1200 – 1600mm

Suitable for use as a Collaborative* or Work-point** setting

Note * Collaborative settings: The worktop pieces and joins will be calculated to provide the best board efficiency

****** Work-point settings: The number of work-points must be specified.

The individual work-point length limitations are minimum 1200mm to maximum 2400mm.

Each work-point on the table will be equal in length.

Height Range

Fixed Height: 720mm, 900mm & 1050mm

Options

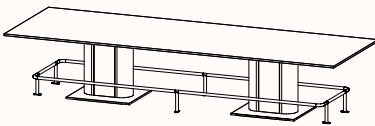

Foot Rail

Available on 1050mmH tables only

Collaborative Setting: The vertical support post quantity & spacing will be calculated to ensure strength & stability.

Work-Point Setting: Vertical support posts will be spaced according to the number of seating positions.

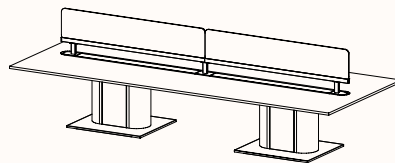

Sky Rail

Consists of an elevated Ctrl Screen Rail

Compatible with Ctrl Screens

The quantity of posts is calculated to ensure strength & stability.

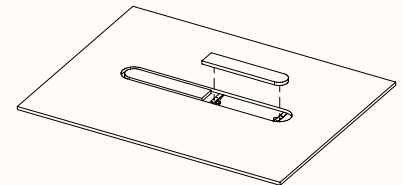

Click-in Lids

Provide quick and easy access to Power/data outlets under the worktop
Capsule shaped

The quantity of lids is calculated to ensure ease of use.

Capsule Modesty Fixed Height Pedestal – Twin

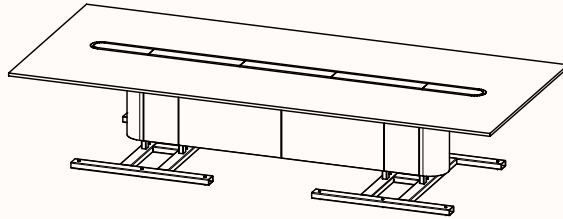
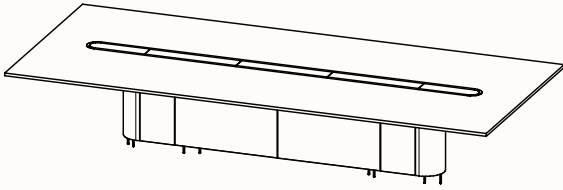

Capsule Modesty Twin Pedestal with Fixed Base

(Bolt to Slab)

Table length range: 2800 – 5600mm

Table depth range: 1200 – 1800mm

Capsule Modesty Twin Pedestal with Access Floor Base

(Floating Base)

Table length range: 2800 – 5600mm

Table depth range: 1200 – 1600mm

Suitable for use as a Collaborative* or Work-point** setting

Note * Collaborative settings: The worktop pieces and joins will be calculated to provide the best board efficiency

****** Work-point settings: The number of work-points must be specified.

The individual work-point length limitations are minimum 1200mm to maximum 2400mm.

Each work-point on the table will be equal in length.

Height Range

Fixed Height: 720mm, 900mm & 1050mm

Options

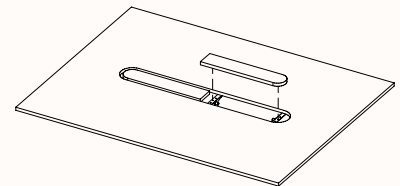
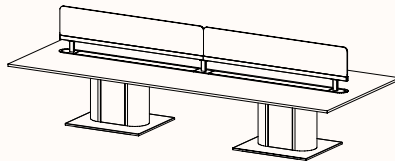
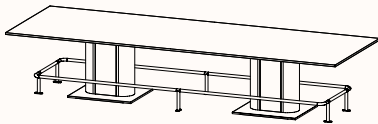

Foot Rail

Available on 1050mmH tables only

Collaborative Setting: The vertical support post quantity & spacing will be calculated to ensure strength & stability.

Work-Point Setting: Vertical support posts will be spaced according to the number of seating positions.

Sky Rail

Consists of an elevated Ctrl Screen Rail

Compatible with Ctrl Screens

The quantity of posts is calculated to ensure strength & stability.

Click-in Lids

Provide quick and easy access to

Power/data outlets under the worktop

Capsule shaped

The quantity of lids is calculated to ensure ease of use.

Capsule Plus Fixed Height Pedestal - Single

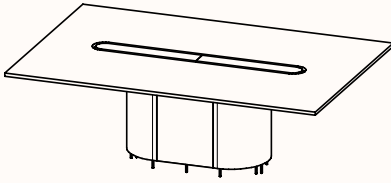

Capsule Plus Single Pedestal with Fixed Base

(Bolt to Slab)

Table length range: 1600 - 3600mm

Table depth range: 1500 - 2000mm

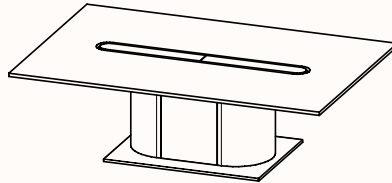

Capsule Plus Single Pedestal with Above Floor Base

(Floating Base)

Table length range: 1600 - 3200mm

Table depth range: 1500 - 1800mm

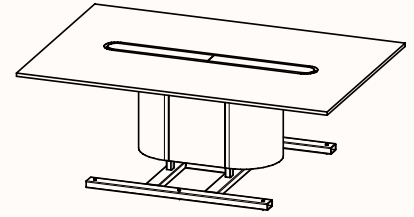

Capsule Plus Single Pedestal with Access Floor Base

(Floating Base)

Table length range: 1600 - 3200mm

Table depth range: 1500 - 1800mm

Suitable for use as a Collaborative* or Work-point** setting

Note * Collaborative settings: The worktop pieces and joins will be calculated to provide the best board efficiency

****** Work-point settings: The number of work-points must be specified.

The individual work-point length limitations are minimum 1200mm to maximum 2400mm.

Each work-point on the table will be equal in length.

Height Range

Fixed Height: 720mm, 900mm & 1050mm

Options

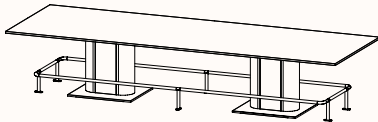

Foot Rail

Available on 1050mmH tables only

Collaborative Setting: The vertical support post quantity & spacing will be calculated to ensure strength & stability.

Work-Point Setting: Vertical support posts will be spaced according to the number of seating positions.

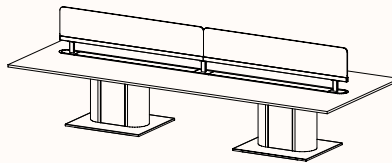

Sky Rail

Consists of an elevated Ctrl Screen Rail

Compatible with Ctrl Screens

The quantity of posts is calculated to ensure strength & stability.

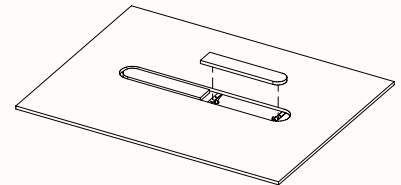

Click-in Lids

Provide quick and easy access to Power/data outlets under the worktop
Capsule shaped

The quantity of lids is calculated to ensure ease of use.

Capsule Plus Electric Adjust Pedestal – Single

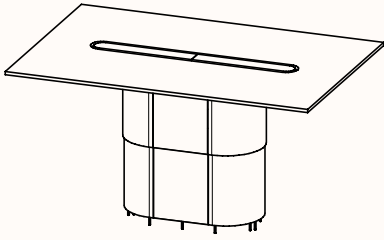

Capsule Plus Single Pedestal with Fixed Base

(Bolt to Slab)

Table length range: 1600 – 2400mm

Table depth range: 1500 – 1800mm

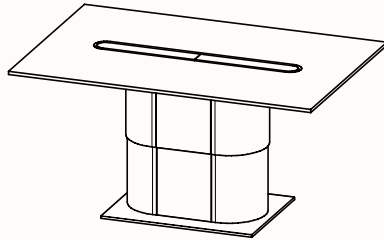

Capsule Plus Single Pedestal with Above Floor Base

(Floating Base)

Table length range: 1600 – 2400mm

Table depth range: 1500 – 1600mm

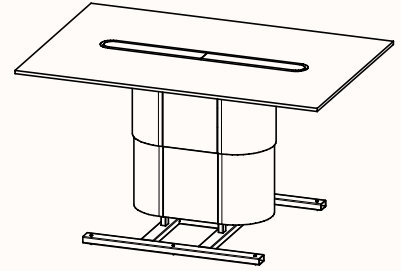

Capsule Plus Single Pedestal with Access Floor Base

(Floating Base)

Table length range: 1600 – 2400mm

Table depth range: 1500 – 1600mm

Suitable for use as a Collaborative* setting

Note * Collaborative settings: The worktop pieces and joins will be calculated to provide the best board efficiency

Height Range

Electric Adjust: 670 – 1200mm

Options

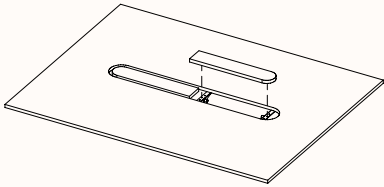

Click-in Lids

Provide quick and easy access to

Power/data outlets under the worktop

Capsule shaped

The quantity of lids is calculated to ensure ease of use.

Capsule Plus Electric Adjust – Single Sided

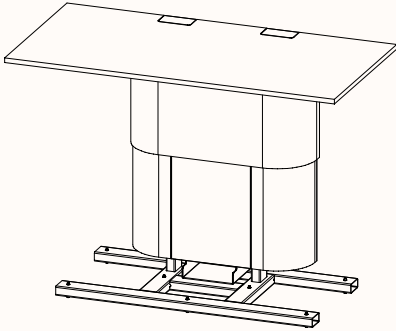

Capsule Plus Single Sided with Access Floor Base

(Floating Base)

Table length range: 1400 – 1800mm

Table depth range: 750 – 900mm

Suitable for use as a Work-point setting.

Available with Click-in Lids which provide quick and easy access to Power/data outlets under the worktop. Capsule shaped. The quantity of lids is calculated to ensure ease of use.

Height Range

Electric Adjust: 670 – 1200mm

Options

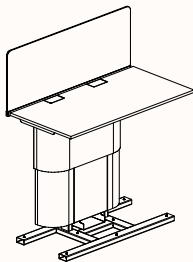

Ctrl Screen Rail & Ctrl Screen

Compatible with Ctrl Screen Rail
(Worktop Mounted) & Ctrl Screen

Rear worktop to Ctrl Rail gap = Zero – 30mm

Capsule Plus Electric Adjust – Pod 2

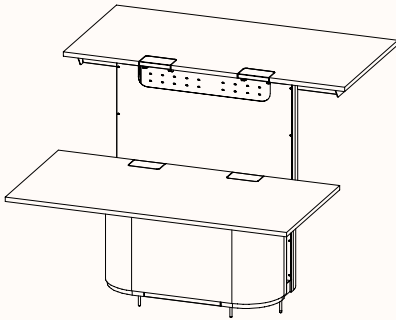

Capsule Plus Pod 2 with Fixed Base

(Bolt to Slab)

Table length range: 1400 - 1800mm

Table depth range: 750-900mm

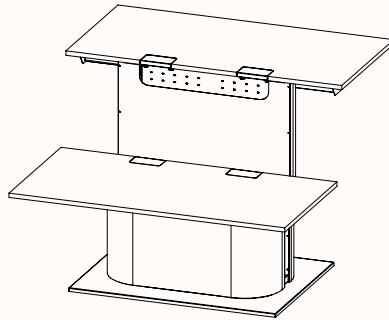

Capsule Plus Pod 2 with Above Floor Base

(Floating Base)

Table length range: 1400 - 1800mm

Table depth range: 750-900mm

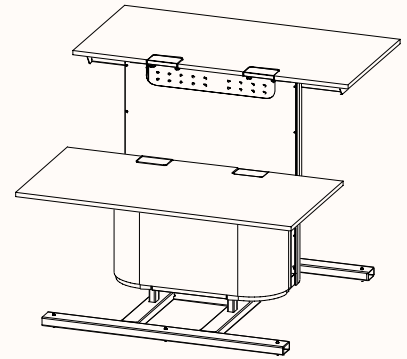

Capsule Plus Pod 2 with Access Floor Base

(Floating Base)

Table length range: 1400 - 1800mm

Table depth range: 750-900mm

Suitable for use as a Work-point** setting

Available with Click-in Lids which provide quick and easy access to Power/data outlets under the worktop.

Capsule shaped. The quantity of lids is calculated to ensure ease of use.

Note ** Work-point settings: Quantity of 2 Work-points must be specified.

The individual work-point length limitations are minimum 1200mm to maximum 2400mm.

Each work-point on the table will be equal in length.

Height Range

Electric Adjust: 670 – 1200mm

Options

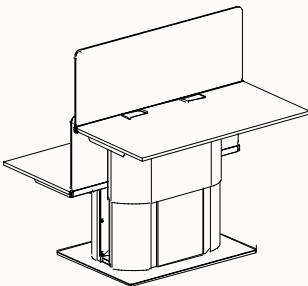

Ctrl Screen Rail & Ctrl Screen

Compatible with Ctrl Screen Rail

(Worktop Mounted) & Ctrl Screen

Rear worktop to Ctrl Rail gap = Zero only