

# MEKOS Standing Table



## Features:

Toying with tension, the distinguishing feature of the Mekos standing table is the hoop leg form. The curved inner leg and soft lines more reminiscent of residential design, are contrasted with sharp, crisp lines expressed on the outside of the leg. The Mekos standing tables allows employees to change their working position according to task, offering increased connection and easy collaboration.

## Options:

- Team tables and small tables
- Omni lid: Rectangular or capsule shape with or without sharknose edge
- Omni duct lite with omni lid and optional powerblade

**Design:** ZENITH DESIGN STUDIO

**Warranty:** 10 years

**Certifications:** GECA, Greenguard, Greenguard Gold

## Finishes:

Top: One or two-tone 25mm Zenith standard laminates

Omni lid: Zenith standard laminates

Frame: Zenith House powder coat Matt/Satin/

Fine Texture range

Custom colours available upon request

Stocked models and colours may vary

## Zenith House Powder Coat:



**Cool White**  
(Satin/  
Fine Texture)



**Warm White**  
(Matt)



**Cool Grey**  
(Satin/  
Fine Texture)



**Gum Grey**  
(Fine Texture)



**Monument**  
(Matt)



**Black**  
(Satin/ Matt/  
Fine Texture)



**Chocolate**  
(Fine Texture)



**Burnt Umber**  
(Fine Texture)



**Blush Pink**  
(Fine Texture)



**Rust**  
(Fine Texture)



**Sky Blue**  
(Fine Texture)



**Indigo**  
(Fine Texture)



**Olive**  
(Fine Texture)

## Dimensions

### Small Tables

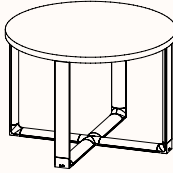
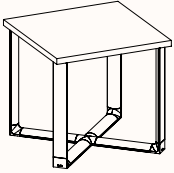
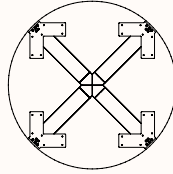
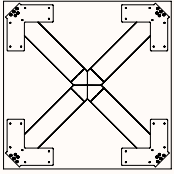

#### Standing Table MKCS-SQR1

OW 600-1000mm  
OD 600-1000mm  
OH 750-1050mm

#### Standing Table MKCS-RND1

DIA 600-1000mm  
OH 750-1050mm

\*Note: The above tables can achieve other heights, please refer to the other Mekos specifications on the website.

### Standing Team Tables

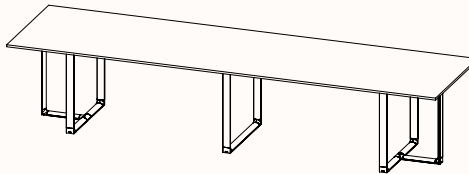
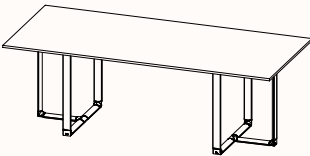
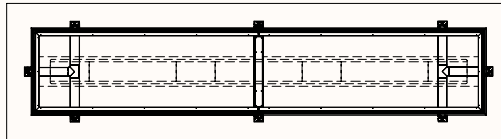
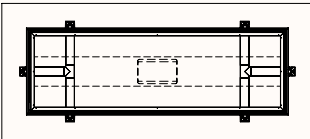

#### Standing Table MKO-REC2

OW 2000-3200mm  
OD 1000-1600mm  
OH 900/1050mm

#### Standing Table MKO-REC3

OW 3200-5200mm  
OD 1000-1600mm  
OH 900/1050mm

Suitable with 1, 2, 3 or 4 Omni lids depending on table length.  
Compatible with Omni duct lite, with optional powerblade.

Suitable with 2 or 4 Omni lids.  
Compatible with Omni duct lite, with optional powerblade.

## Dimensions

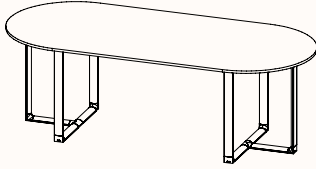
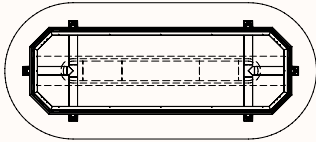

### Standing Table MKO-RND2

OW 2400-3200mm  
OD 1200-1600mm  
OH 900/1050mm

Suitable with 1 or 2 Omni lids depending on table length.  
Compatible with Omni duct lite, with optional powerblade.

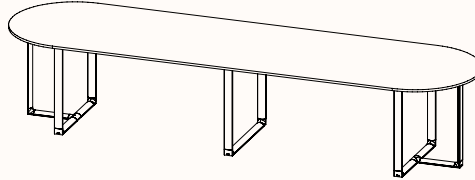
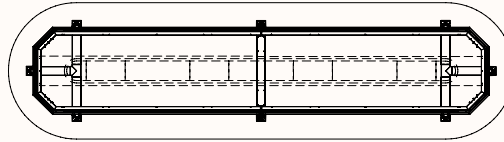

### Standing Table MKO-RND3

OW 3200-5200mm  
OD 1200-1600mm  
OH 900/1050mm

Suitable with 2 or 4 Omni lids.  
Compatible with Omni duct lite, with optional powerblade.

## 2 -Tone Tops

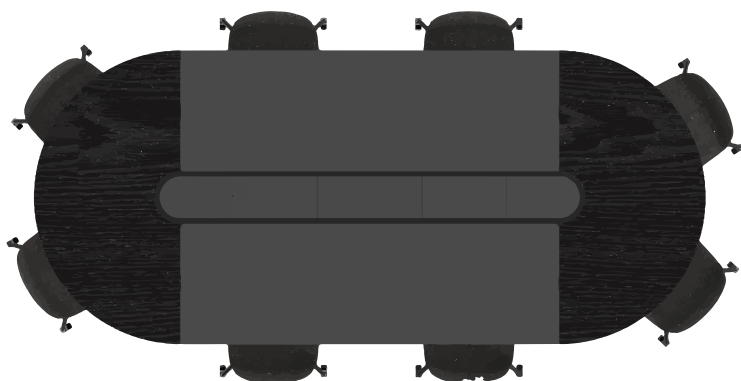

### Standing Table

**MKO-RND2 | MKO-RND3**

Omni Lid finish can match outer top selection

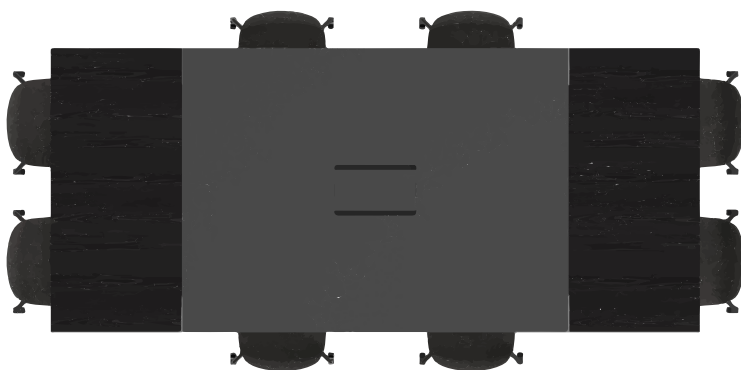

### Standing Table

**MKO-REC2 | MKO-REC3**

Omni Lid finish can match outer top selection

## Cable Management

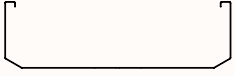

### Omni Duct Lite

W 300mm  
H 88.5mm

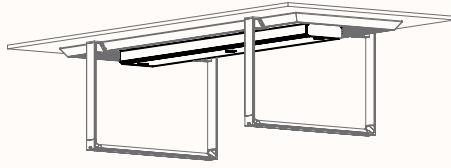

### Omni Duct Lite Closed

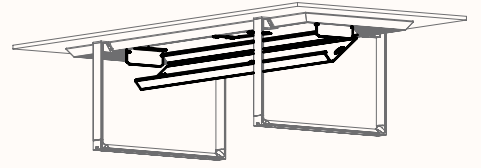

### Omni Duct Lite Open

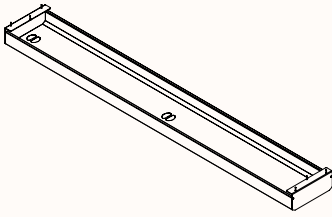

### Full length Omni Duct Lite

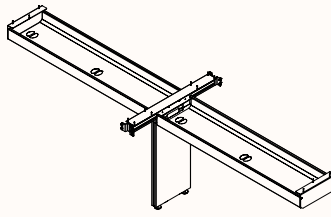

### 2 piece Omni Duct Lite with Powerblade

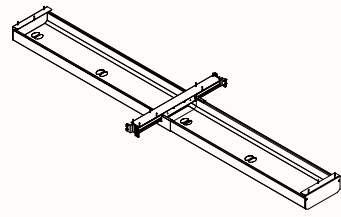

### 2 piece Omni Duct Lite without Powerblade

## Cable Management

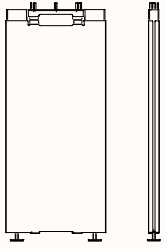

### Powerblade

W 300mm

D 40mm

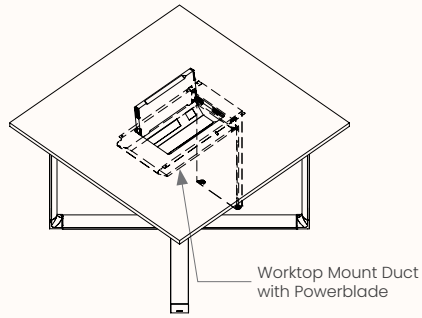

### Top Mount Plate & Worktop Mount Duct with Powerblade

Compatible with any table with 1 Omni lid.

Not compatible with Omni Duct Lite.

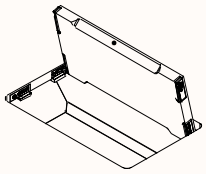

### Omni Lid:

Rectangular or Capsule

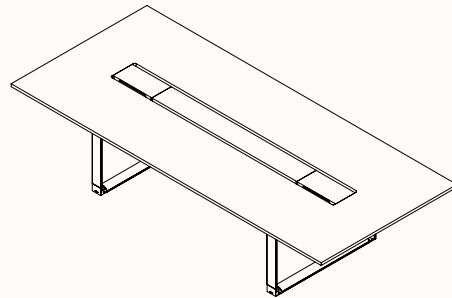

### Rectangular Omni Lid

Compatible tables:

- MKU-REC2/MKU-REC3
- MKO-REC2/MKO-REC3
- MKTM-REC2
- MKC-SQR1/MKC-RND1

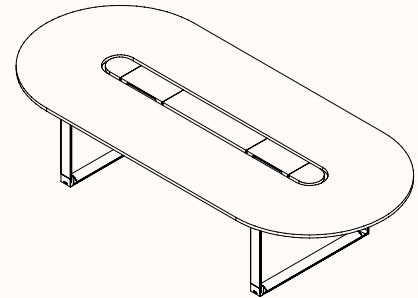

### Capsule Omni Lid

Compatible tables:

- MKU-RND2/MKU-RND3
- MKO-RND2/MKO-RND3