

MEKOS Table



Features:

Toying with tension, the distinguishing feature of the Mekos table is the hoop leg form. The curved inner leg and soft lines more reminiscent of residential design, are contrasted with sharp, crisp lines expressed on the outside of the leg. Mekos tables function as either a collaboration table or dedicated workstation setting, providing a solution for focus or idea exchange, in both formal and informal spaces.

Options:

- Seated meeting tables, team tables and small tables
- Omni lid: Rectangular or capsule shape with or without sharknose edge
- Omni duct lite with omni lid

Design: ZENITH DESIGN STUDIO

Warranty: 10 years

Certifications: Greenguard, Greenguard Gold, GECA, AFRDI

Finishes:

Top: One or two-tone 25mm Zenith standard laminates













Omni lid: Zenith standard laminates

Frame: Zenith House powder coat Matt/Satin/
Fine Texture range

Custom colours available upon request

Stocked models and colours may vary

Zenith House Powder Coat:

					
Cool White (Satin/ Fine Texture)	Warm White (Matt)	Cool Grey (Satin/ Fine Texture)	Gum Grey (Fine Texture)	Monument (Matt)	Black (Satin/ Matt/ Fine Texture)
					
Chocolate (Fine Texture)	Burnt Umber (Fine Texture)	Blush Pink (Fine Texture)	Rust (Fine Texture)	Sky Blue (Fine Texture)	Indigo (Fine Texture)
					
Olive (Fine Texture)					

Dimensions

Small Tables

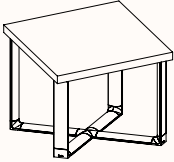
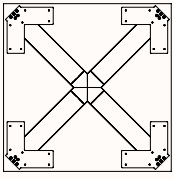

Small Table MKCS-SQR1

OW 600-1000mm
OD 600-1000mm
OH 600-750mm

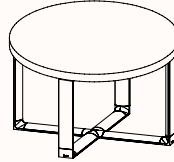
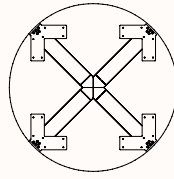

Small Table MKCS-RND1

DIA 600-1000mm
OH 600-750mm

*Note: The above tables can achieve other heights, please refer to the other Mekos specifications on the website.

Dimensions

Seated Meeting Tables

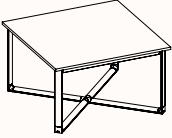
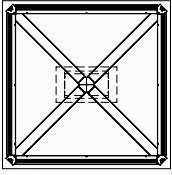

Meeting Table MKC-SQR1

OW 900-1800mm
OD 900-1800mm
OH 720/750mm

Suitable with 1x Omni Lid and worktop mounted cable management products

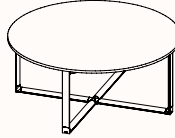
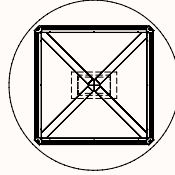

Meeting Table MKC-RND1

DIA 900-1800mm
OH 720/750mm

Suitable with 1x Omni Lid and worktop mounted cable management products

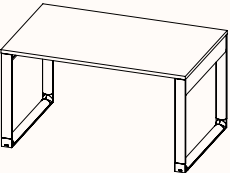
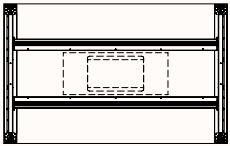

Meeting Table MKTM-REC2

OW 1000-2400mm
OD 1000-1800mm
OH 720/750mm

Suitable with 1x Omni Lid and worktop mounted cable management products

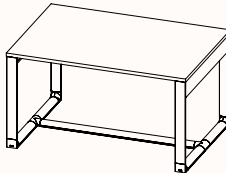

Meeting Table MKTM-S

OW 1000-2400mm
OD 1000-1800mm
OH 720/750mm

Dimensions

Seated Team Table

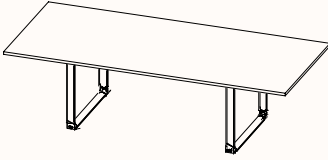
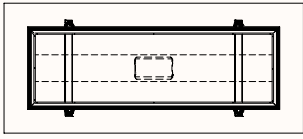

Team Table MKU-REC2

OW 1600-3200mm
OD 1000-1800mm
OH 720/750mm

Suitable with 1, 2, 3 or 4 Omni lids depending on table length.
Compatible with Omni duct lite, with optional powerblade.

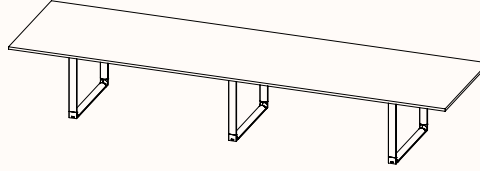
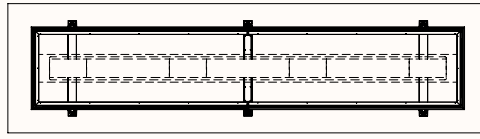

Team Table MKU-REC3

OW 3200-5200mm
OD 1000-1800mm
OH 720/750mm

Suitable with 2 or 4 Omni lids.
Compatible with Omni duct lite, with optional powerblade.

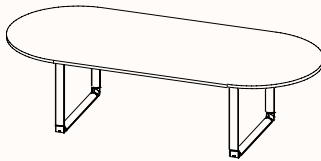
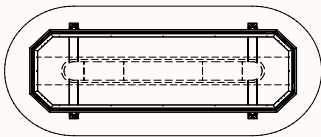

Team Table MKU-RND2

OW 2800-3200mm
OD 1200-1600mm
OH 720/750mm

Suitable with 1 or 2 Omni lids depending on table length.
Compatible with Omni duct lite, with optional powerblade.

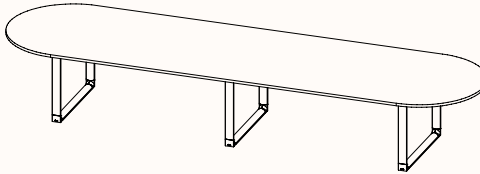
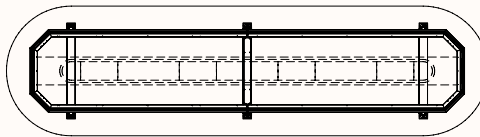

Team Table MKU-RND3

OW 3200-5200mm
OD 1200-1600mm
OH 720/750mm

Suitable with 2 or 4 Omni lids.
Compatible with Omni duct lite, with optional powerblade.

2 - Tone Tops

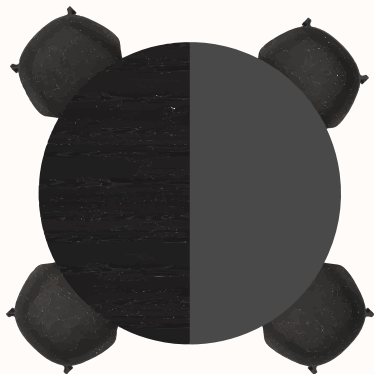

Meeting Table
MKC-RND1

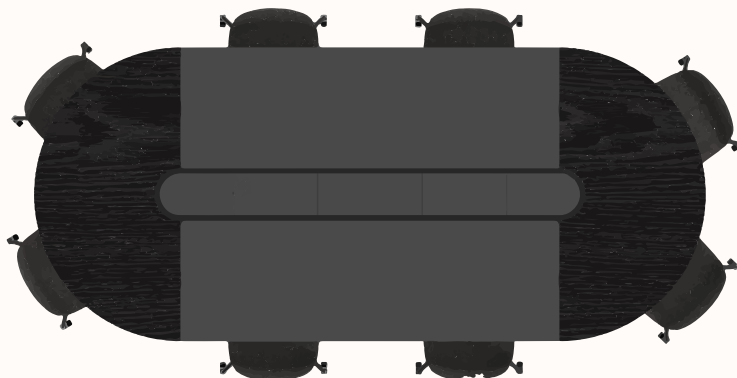

Team Table
MKU-RND2 | MKU-RND3
Omni Lid finish can match outer top selection

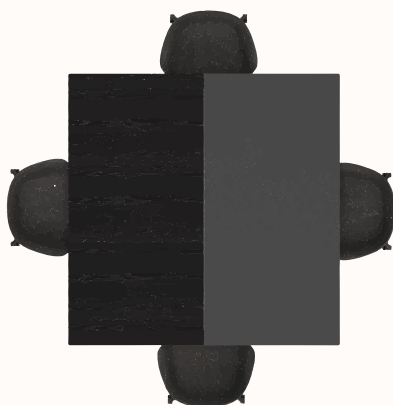

Meeting Table
MKC-SQR1

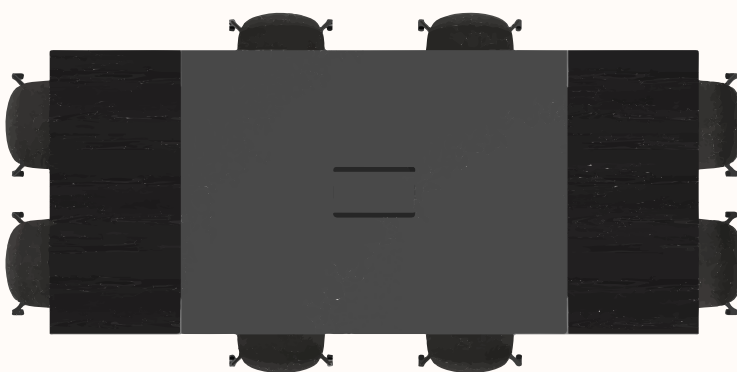

Team Table
MKU-REC2 | MKU-REC3
Omni Lid finish can match outer top selection

Cable Management



Omni Duct Lite

W 300mm
H 88.5mm

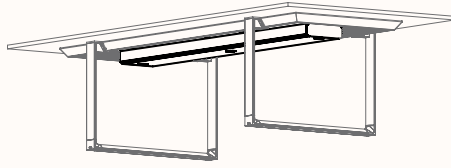

Omni Duct Lite Closed

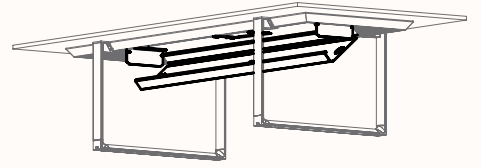

Omni Duct Lite Open

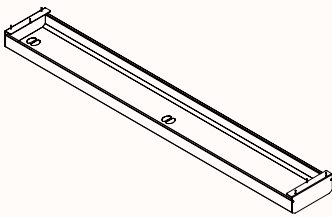

Full length Omni Duct Lite

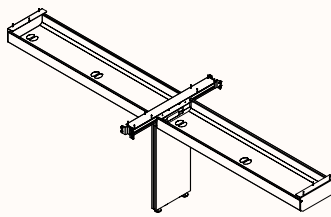

2 piece Omni Duct Lite with Powerblade

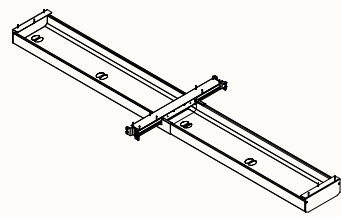

2 piece Omni Duct Lite without Powerblade

Cable Management

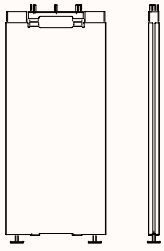

Powerblade

W 300mm

D 40mm

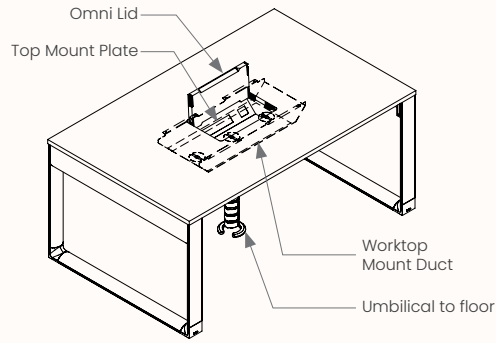

Top Mount Plate & Worktop Mount Duct without Powerblade

Compatible with any table with 1 Omni lid.

Not compatible with Omni Duct Lite.

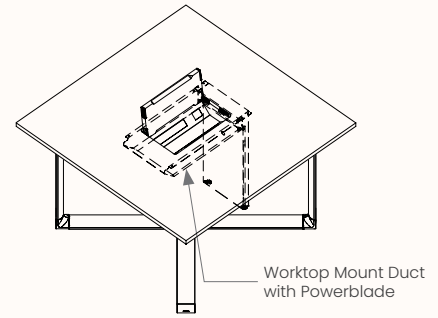

Top Mount Plate & Worktop Mount Duct with Powerblade

Compatible with any table with 1 Omni lid.

Not compatible with Omni Duct Lite.

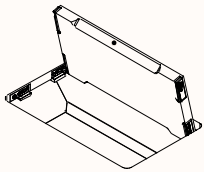

Omni Lid:

Rectangular or Capsule

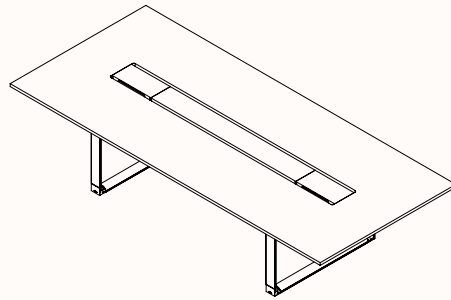

Rectangular Omni Lid

Compatible tables:

- MKU-REC2/MKU-REC3
- MKO-REC2/MKO-REC3
- MKTM-REC2
- MKC-SQR1/MKC-RND1

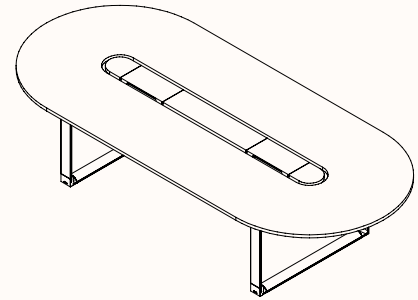

Capsule Omni Lid

Compatible tables:

- MKU-RND2/MKU-RND3
- MKO-RND2/MKO-RND3