

A close-up photograph of a modern chair. The chair features a textured, woven fabric in a light beige or tan color with a subtle pattern of small, dark brown or red specks. The fabric is draped over a dark red, cylindrical wooden leg. The background is a plain, light-colored wall and floor, creating a clean, minimalist aesthetic. The lighting is soft, highlighting the texture of the fabric and the smooth finish of the wood.

Zenith

Alter

Design by Scott Fitzsimons





Minimal & elegant expression

Zenith's ALTER collection, designed by New Zealand-based Scott Fitzsimons, redefines the modern workplace with elegant solutions for every interaction from impromptu chats to formal meetings. Featuring a minimalist aesthetic, ALTER's extended range includes lounge chairs, benches, and coffee tables featuring timeless timber finishes and soft inviting seating.

Also available in a durable steel frame, the ALTER Metal range offers a stylish yet robust option for high-traffic spaces, such as dining, breakout, and reception areas. Together, the Alter range embodies the perfect balance of charm, warmth, and functionality for the cultivated workspace.



The beauty of solid wood is celebrated in the refined frame, gently supporting the soft and inviting seating surfaces above and matched with a warm palette rarely seen in workplace furniture. By humanising the workspace and emulating the aesthetic of the domestic environment, we experience a sense of familiarity and emotional comfort.

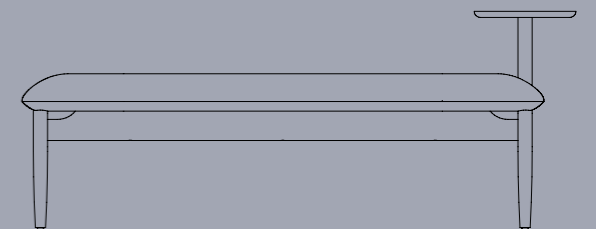
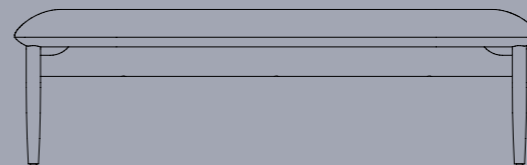
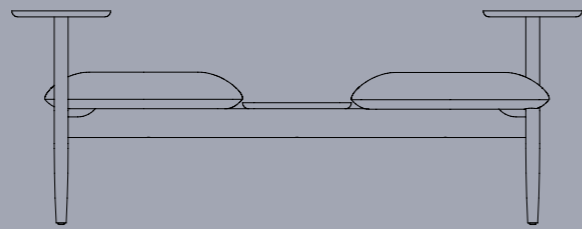
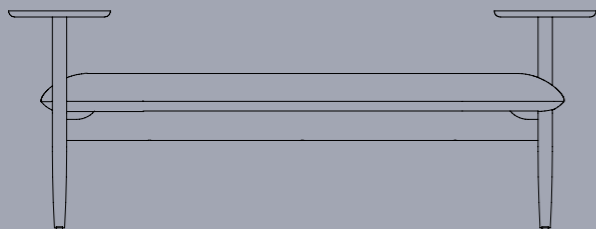
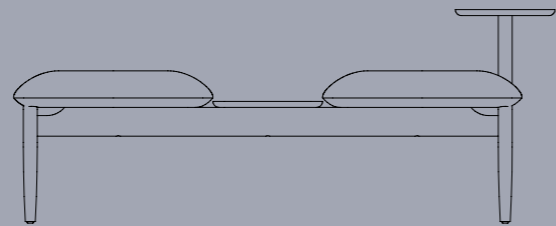
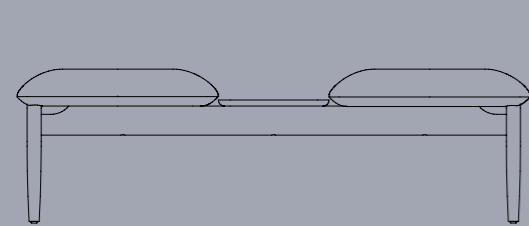
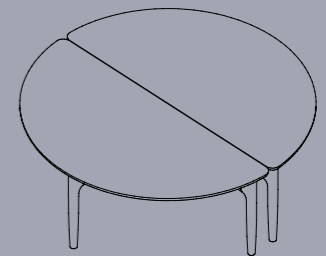
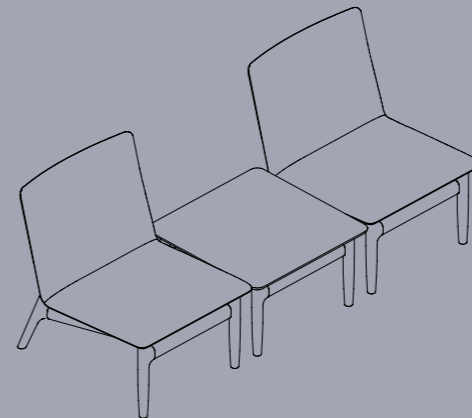
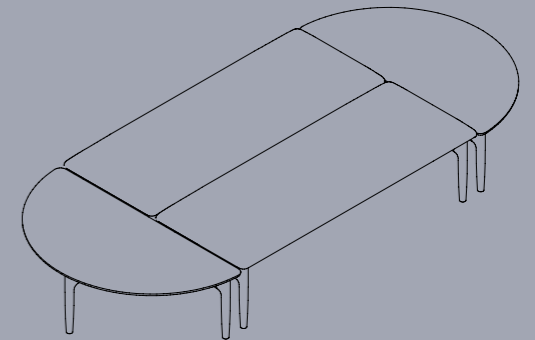
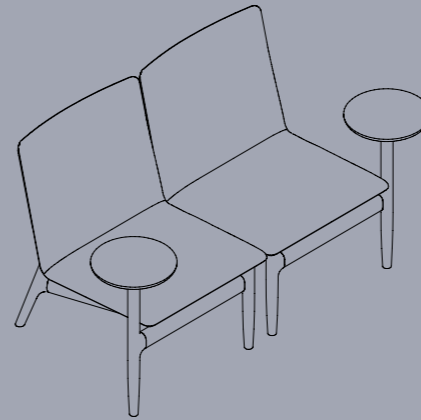
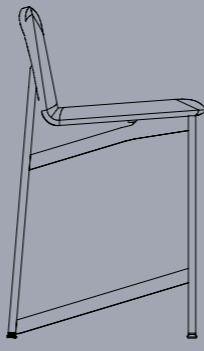
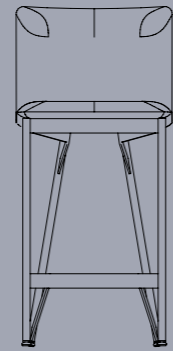
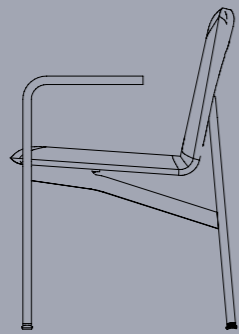
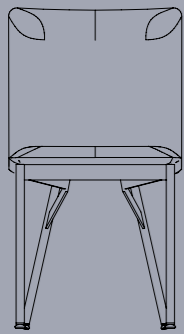
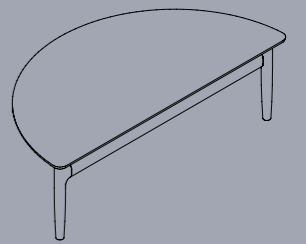
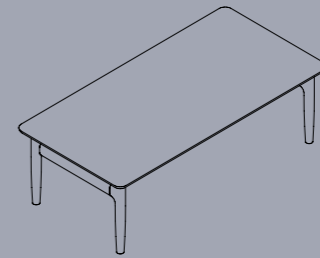
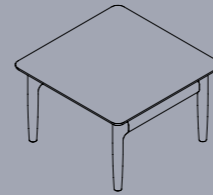
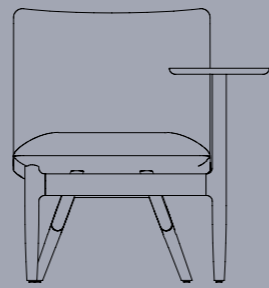
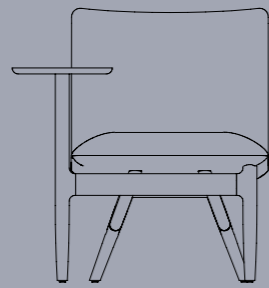
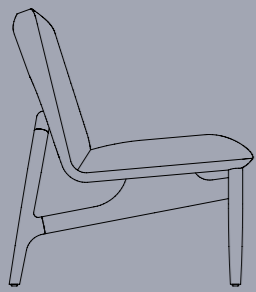



Timeless & Elegant

Built from solid materials that will last beyond passing trends and endure the rigours of the modern commercial office.







Scott

Fitzsimons

Scott Fitzsimons Studio is a strategic multidisciplinary design office based in New Zealand, with a focus on creating original and meaningful objects, spaces and brands.

Our passion lies in the creation of products with an underlying philosophy of simplicity, timelessness and permanence. Our work is not based on fashion or trends, but rather, is authentic and honest.

A deep understanding and passion for materials and processes is the driver behind the studio achieving a high level of detail and craftsmanship in our work. We are uncompromising in our pursuit of quality.

We design products that are durable, functional and engaging, combining innovative functionality with a restraint and visual reduction in aesthetics, and meticulous attention to detail.

We are devoted to designing products that are environmentally and socially responsible and user requirements.



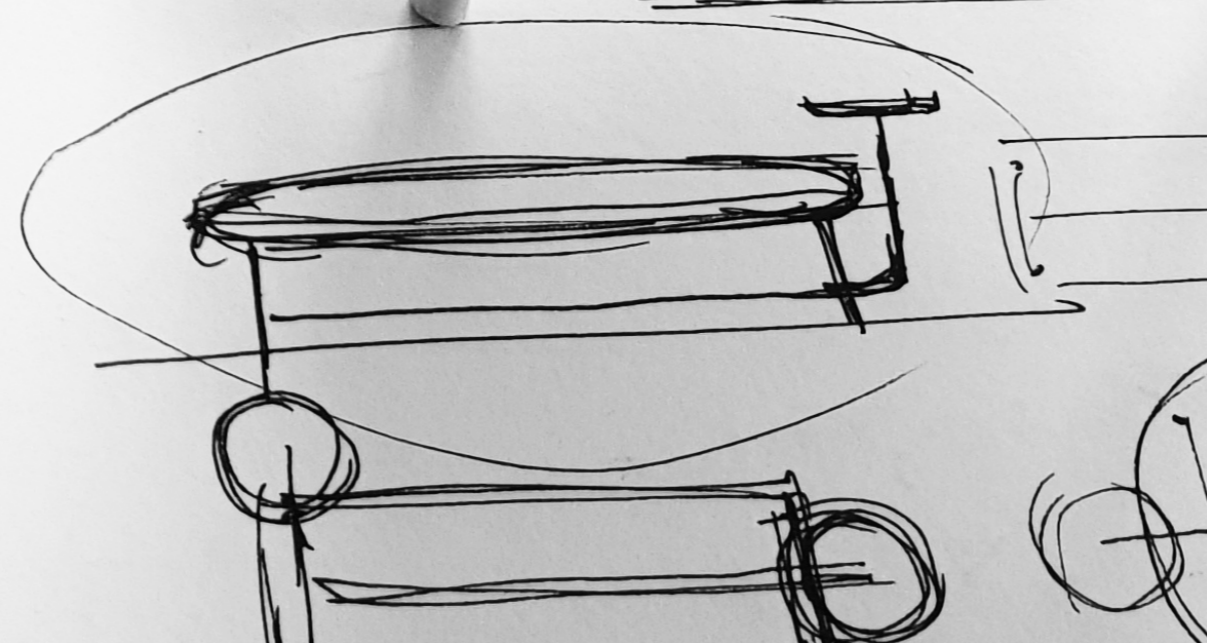
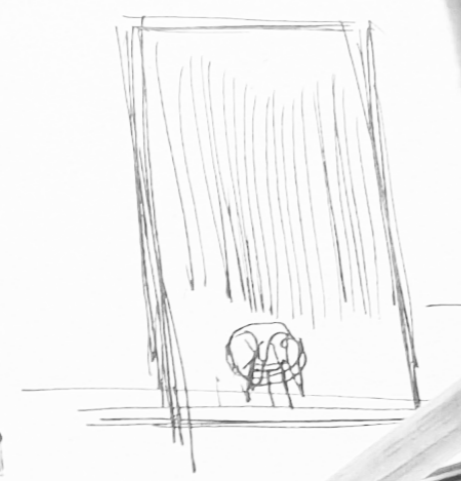
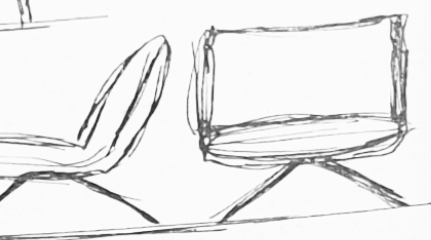

“The ALTER range is designed for both the planned and the impromptu, as a mobile collection of seating and occasional tables that offers a nimble approach to social or formal gatherings in the workplace. Offering a space for nomadic workers to choose where and with whom they work. A space where impromptu meetings for the sharing of ideas and collaborative discussions can occur. The ALTER range offers a lounge setting that feels familiar, where one can pause alone to focus on the task at hand, and equally, serendipitous connections and social interactions can occur.”

Scott Fitzsimons

Zenith

We've worked with interior designers, architects and workplace curators for many years. Together, we've developed a range of internal workspace environments. We work alongside these curators of modern workspaces to redefine the environments where people live, work, socialise, interact and learn.

Contemporary workplaces have to combine leading edge technology and physical elements in a way that produces productive environments for organisations. And every organisation is unique. So before we recommend a solution, we work hard to understand the organisation and the people who define its culture.

Our local teams and showrooms deliver the support you need. Our global logistics guarantees the highest quality product, service and delivery schedules.

Showroom locations

Australia Melbourne, Sydney, Canberra, Brisbane, Perth, Adelaide

New Zealand Auckland, Wellington, Christchurch

Asia Hong Kong, Shanghai, Singapore, Shenzhen

zenithinteriors.com