

zenithinteriors.com

FRAMED (S30/S50) Screen

Zenith

Features:

Framed Screens: S30 and S50 are exceedingly well resolved and comprehensive. The functional and aesthetic screens are both highly versatile and reconfigurable. They are structural elements that support a wide range of accessories and shelves. S30 and S50 have attractive clean lines that compliment the Zenith workstation ranges and lift the surrounding environment.

The S30 and S50 range includes junction posts and caps that will accommodate 90° and 120° 2-way, 3 way and 4 way intersections. The S50 screen is available fitted to the workstation AFFL, taken down to the floor or installed as a full height powerblade. The S50 panel can be fitted with mid level ducting wired, and in conjunction with the Hex post or Combi Post, provides hidden wire reticulation and a wide range of outlet options.

Options:

- Extended Stile LHS/RHS or Both Sides
- Sonic Board Single or Double

Compatibility:

- Orbis Workstation
- Rumba Workstation
- Epic Plus Workstation
- Silhouette Workstation

Design: ZENITH DESIGN STUDIO

Warranty: 10 years

Certifications: GECA, FSC, VOC

Finishes:

Frame: Powder coat

Screen: Upholstered in Zenith Screen fabric or COM

Sonic Board

Echo Panel: Single or double

Glazing 6.38mm

Whiteboard 4.5mm or 6mm

Plain Metal

Perforated Metal

Forbo Board 6mm

Laminate

Twin Wall Polycarbonate 6mm

Refer to Zenith House Finishes Specification for full range

Sonic Board:



Milky White
ZPET_009



Silver
ZPET_006



Light Grey
ZPET_004



Ash
ZPET_007



Black
ZPET_003

Powder Coat:



Cool White
(Satin/ Matt)



Warm White
(Matt)



Cool Grey
(Satin)



Monument
(Matt)



Black
(Satin/ Matt)

Screen Types

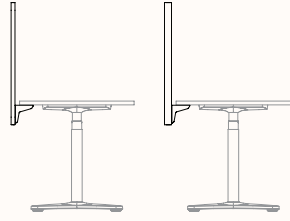

S30

S50

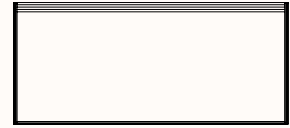
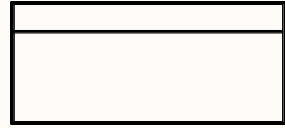

Type 1 Standard

S30 & S50

Type 2 Transom Rail

S30 & S50

Type 7 Transom Rail

S30 & S50

Type 8 Landscape Rail

S30

Framed (S30/S50) Screens

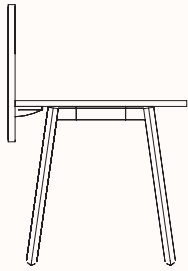

S30 Screen

180 Degree

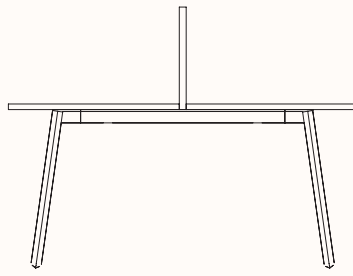

S30 Screen

180 Degree Pod of 2

Note: Drawing indicative only

Framed (S30/S50) Screens
ORBIS Workstation

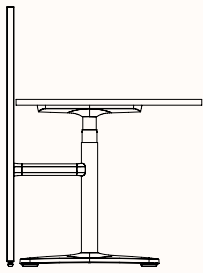

Single Desk Screen to Floor

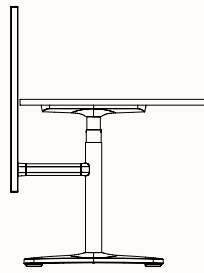

Single Desk with Screen Above Floor Level

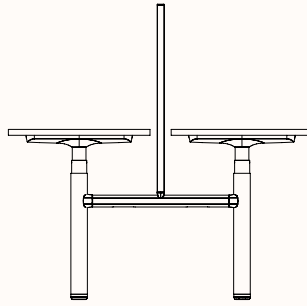

Pod with Screen Cross Beam Mounted

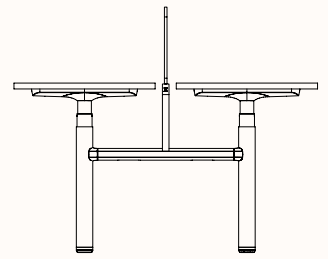

Pod with Screen in CTRL Rail

120 Degree Orbis Hex Post

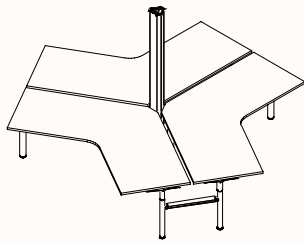

Pod of 3 with Hex Post

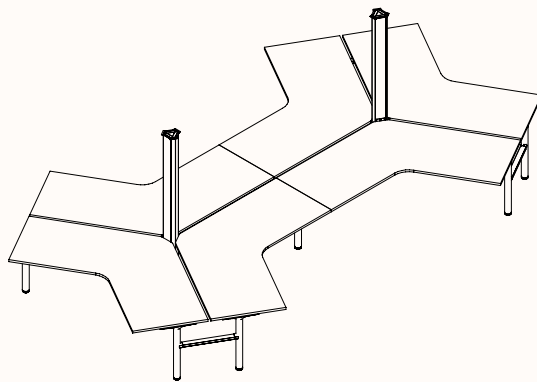

Pod of 6 with Hex Post*

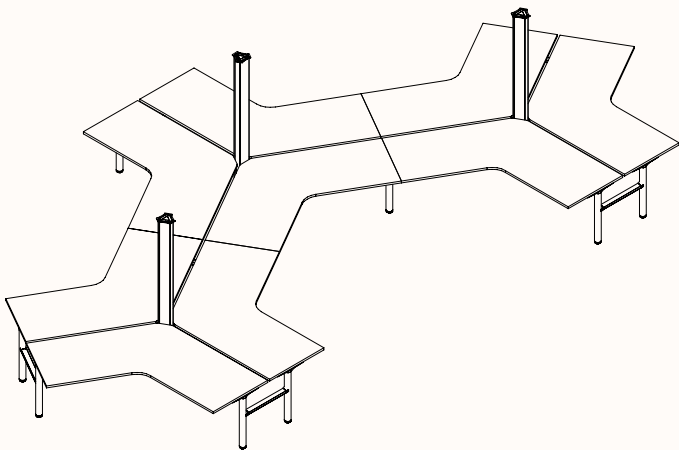

Pod of 9 with Hex Post*

Height Range

- Fixed Height: 720mm*
- Tech Adjust: 610-900mm
- Winder Adjust: 610-900mm
- Electric Adjust: 620-1230mm

Note: * Pod of 6 & 9 with Hex Post is only available in Fixed Height

Framed (S30/S50) Screens
EPIC PLUS Workstation

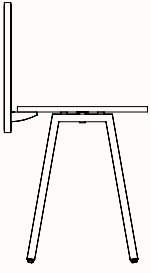

S30 Screen
Worktop Mounted

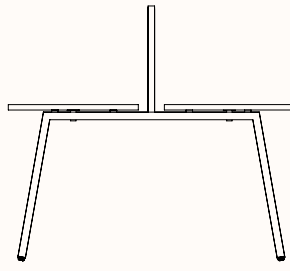

S30 Screen
Frame Mounted

**Framed (S30/S50) Screens
RUMBA Workstation**

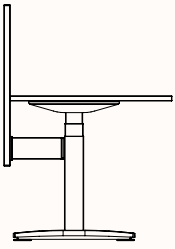

**Single Desk with
Screen Frame Mounted**
180 Degree

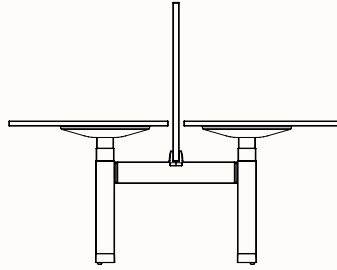

**S30 Screen
Crossbeam Mounted**
180 Degree Pod of 2

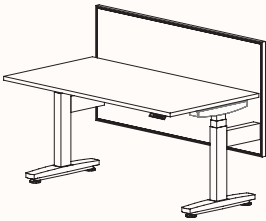

**S30 Screen
Arm Mounted**
180 Degree

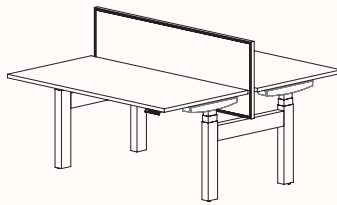

**S30 Screen
Crossbeam Mounted**
180 Degree Pod of 2

120 Degree Hex Post Rumba Workstation

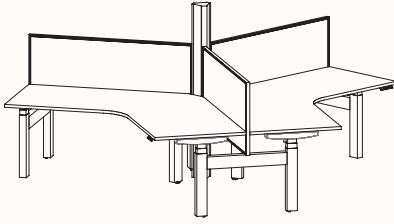

Pod of 3-HP-T2*

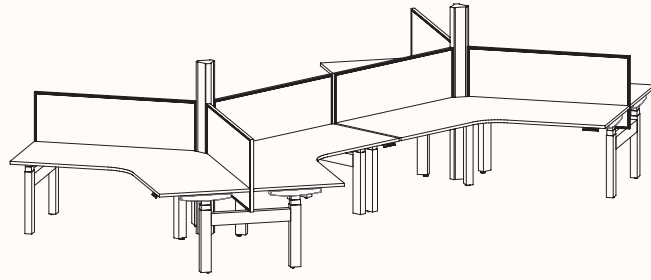

Pod of 6-HP-T2

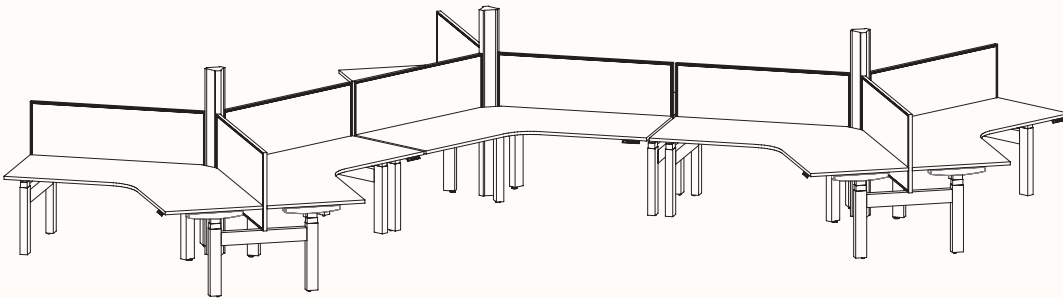

Pod of 9-HP-T2

Height Ranges

Fixed Height	720mm
Tech Adjust	610-900mm
Winder Adjust	610-900mm (sit-sit) 700-1050mm (sit-stand single desks) 700-1100mm (sit-stand pods)
Electric Adjust*	620-1230mm
Electric Adjust (Veyhl)*	650-1310mm (180-Deg with foot) 650-1310mm (180-Pod of 2 without foot)

Note: *Available in 120 Pod of 3-HP-T2 only.